

EIGHT OUTLETS

There's more than one outlet for your power struggle

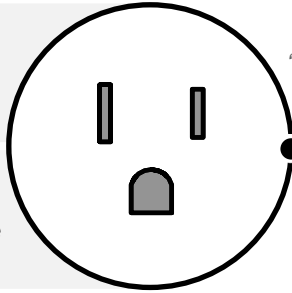

"Plug in a device much??"

2-IN-1 POWER AND CIRCUIT BREAKER SWITCH

Safely shut down your whole system with the flick of a switch

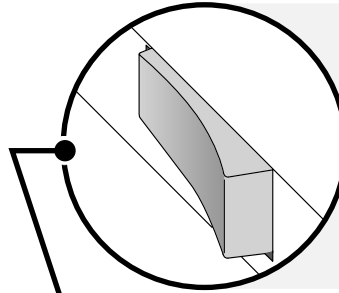

SLIDING SAFETY COVERS

Curb your budding young genius's electrical experiments

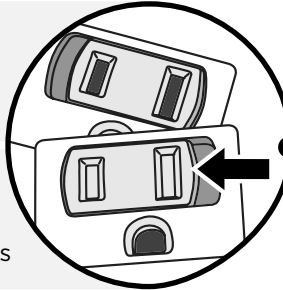

SIX FOOT POWER CORD

"That's almost 5 feet, 12 inches!"

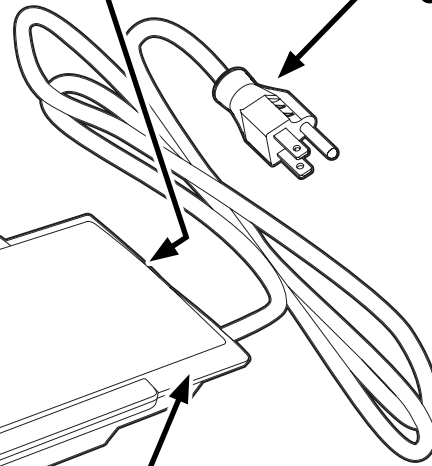

LED INDICATOR LIGHT

Light indicates your stuff is protected*

"Don't try testing with things like a butter knife or a paper clip"

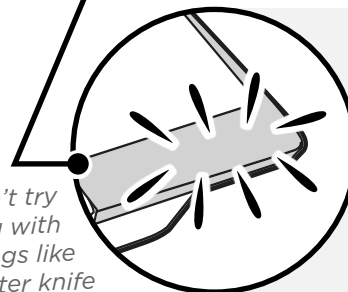

* When the LED INDICATOR no longer lights up, the surge protection has been exhausted and it's time to replace the unit!

ADVANCED INTERNAL COMPONENTS:

- 3420J surge protection
- 58 dB EMI/RFI noise filtering
- X3 fire-proof MOV technology (Metal Oxide Varistor)

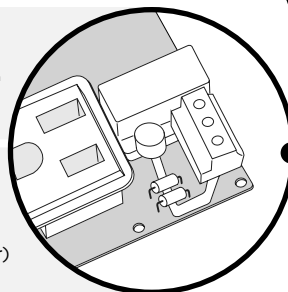

"Science!!"

HANGING SLOTS

For optional wall or cabinet mounting

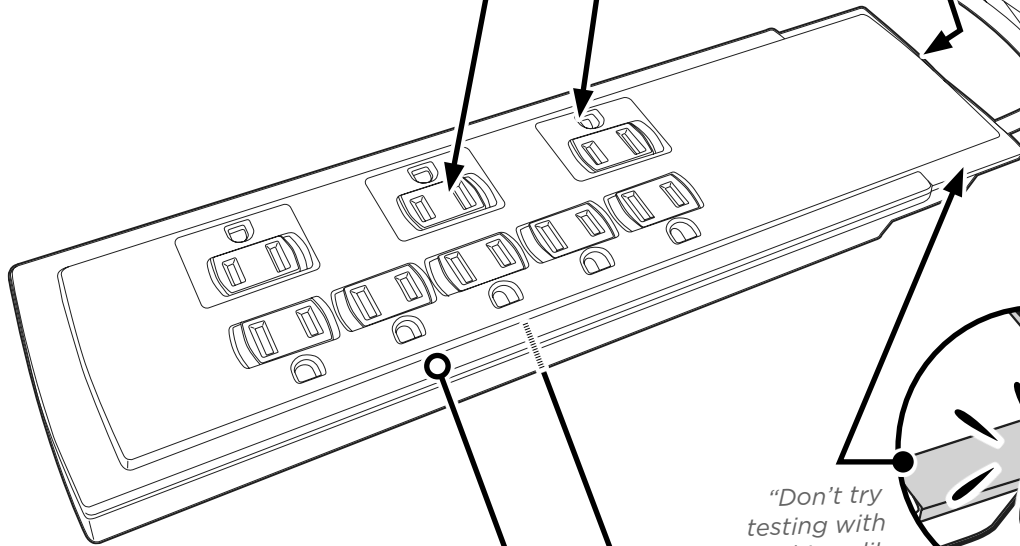
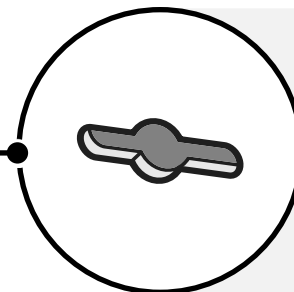

▲ CAUTION!: Avoid potential personal injuries and property damage!

- To Reduce the Risk of Electric Shock - Use Only in Dry Locations, Indoors!
- The input plug of this power tap is intended to serve as the disconnect device, it shall be easily accessible and withdrawn.
- Not for use with ground-fault circuit-interrupter receptacles or receptacles with indicator lights or controls.
- To reduce the risk of fire or electric shock, do not use this device with a receptacle in which the slot openings do not align with the blades.
- All accessories must be grounded.
- Circuit Overloading - Consideration should be given to the connection of the equipment to the supply circuit and the effect that overloading of the circuits might have on overcurrent protection and supply wiring. Appropriate consideration of equipment nameplate ratings should be used when addressing this concern.
- Surge protector must be plugged directly to the power source and must not be "daisy-chained" together (in serial) with other power strips, surge protectors or extension cords.
- Do not use this product for any purpose not explicitly specified by manufacturer.
- If you do not understand these instructions, or have doubts about the safety of the installation, assembly or use of this product, contact Customer Service or call a qualified contractor.
- Do not disassemble the surge protector. Disassembling will void the warranty and may cause serious personal injury.
- Disconnect the surge protector during lightning storms.
- Manufacturer is not responsible for damage or injury caused by incorrect assembly or use.

MILESTONE LIMITED WARRANTY AND CONNECTED EQUIPMENT WARRANTY

Product Warranty

Milestone warrants to the original purchaser that the product shall be free of defects in materials and workmanship under normal use for five (5) years. When this surge protector operates properly and prevents an energy surge from damaging electrical equipment, the surge protective component will disconnect from the circuit and you will need to buy a replacement product. This warranty extends only to the original purchaser and is nontransferable during the warranty period. Milestone will, at no additional charge, repair or replace defective parts or, at its option, replace the entire unit. This warranty does not extend to any Milestone product that has been damaged or rendered inoperable as intended or defective (a) as a result of accident, misuse or abuse; or (b) by the use of parts not manufactured or sold by Milestone; or (c) by modification of the product.

Connected Equipment Damage Warranty

Milestone will also provide you with a remedy for damage to connected equipment if (i) you have a claim that is covered by the limited product warranty described above, and (ii) Milestone receives a formal warranty claim from you before the end of the warranty period for damage to connected equipment applicable to the affected product. If the conditions listed in the preceding sentence are met, Milestone will provide you with one of the following remedies, provided that it may decide at its sole discretion which remedy it provides. Milestone will (1) replace the damaged connected equipment; (2) pay to repair the damaged connected equipment; or (3) pay you the fair market value of the connected equipment, provided that such payments shall not exceed (i) the maximum coverage amount for the product, or (ii) the amount of actual damage caused by power surges due to a product defect. NOTE: Compensation for restoration of data loss is not covered AND MILESTONE DOES NOT ASSUME ANY LIABILITY FOR ANY LOSS OF PROFIT, REVENUE OR SAVING (WHETHER DIRECT OR INDIRECT) OR FOR ANY INCIDENTAL, CONSEQUENTIAL OR INDIRECT DAMAGES UNDER THIS LIMITED WARRANTY. This Connected Equipment Damage Warranty does NOT cover damage caused by lightning or lightning strikes. Some states do not allow the exclusion or limitation of incidental or consequential damages, so the above limitation or exclusion may not apply to you. THE MAXIMUM AMOUNT OF COVERAGE FOR DAMAGE TO PROPERLY CONNECTED EQUIPMENT IS \$25,000. Nothing in this warranty shall exclude or limit liability for death or personal injury caused by negligence, for fraud or fraudulent misrepresentation or where exclusion or limitation is not permitted by law.

Other Rights. THESE LIMITED WARRANTIES GIVE YOU SPECIFIC LEGAL RIGHTS, AND YOU MAY ALSO HAVE OTHER RIGHTS. THIS WARRANTY DOES NOT AFFECT YOUR STATUTORY RIGHTS. THIS WARRANTY EXTENDS ONLY TO YOU, THE ORIGINAL PURCHASER, AND CANNOT BE TRANSFERRED OR ASSIGNED. If any provision of these limited warranties is unlawful, void or unenforceable, that provision shall be deemed severable and shall not affect any remaining provisions. In case of any inconsistency between the English and other versions of these limited warranties, the English version shall prevail.

Registration. Please register your Product at www.milestone.com. Failure to register does not affect your warranty rights.

FORMAL WARRANTY CLAIM

How To Make A Claim. In the event damage has occurred to a Milestone product or to connected equipment, you must contact Milestone within thirty (30) days of the date you knew or should have known of the damages. Follow all instructions for making a claim. THIS REQUIREMENT THAT YOU NOTIFY MILESTONE WITHIN THIRTY (30) DAYS AFTER YOU DISCOVER OR SHOULD HAVE DISCOVERED A PRODUCT DEFECT AFFECTS AND LIMITS YOUR WARRANTY RIGHTS.

GENERAL PROVISIONS

Choice of Law/Jurisdiction. These limited warranties and any disputes arising out of or in connection with these limited warranties ("Disputes") shall be governed by the laws of England and Wales, excluding the Convention for the International Sale of Goods. The courts located in England and Wales shall have exclusive jurisdiction over any Disputes.

TO THE MAXIMUM EXTENT PERMITTED BY LAW THESE LIMITED WARRANTIES ARE IN LIEU OF AND IN PLACE OF ALL OTHER EXPRESS OR IMPLIED WARRANTIES, CONDITIONS AND OTHER TERMS.

Confuzzled? Call the ECHOGEAR Pros:

 1-855-428-2490

 helpmehelpyou@ECHOGEAR.com

"Wanna show off your hard work?
Share a picture of your completed project with #YourGearUpgraded.
Who knows, it might not be as bad as you thought"

Milestone AV Technologies and its affiliated corporations and subsidiaries (collectively, "Milestone"), intend to make this manual accurate and complete. However, Milestone makes no claim that the information contained herein covers all details, conditions, or variations. Nor does it provide for every possible contingency in connection with the installation or use of this product. The information contained in this document is subject to change without notice or obligation of any kind. Milestone makes no representation of warranty, expressed or implied, regarding the information contained herein. Milestone assumes no responsibility for accuracy, completeness or sufficiency of the information contained in this document.

©2018 Milestone AV Technologies. All rights reserved. ECHOGEAR is a Milestone brand. ECHOGEAR and the ECHOGEAR logo are trademarks of Milestone. Made in China.

Milestone Global Headquarters • 6436 City West Parkway • Eden Prairie, MN 55344 USA