

ECHOGEAR

#YourGearUpgraded

IN-WALL CABLE MANAGEMENT BRUSH PLATES

Model **EGAV-CMIWBPW**

Installation Instructions

Doc. #1507311 11/19 Rev A

IMPORTANT SAFETY INSTRUCTIONS

PLEASE READ ENTIRE MANUAL PRIOR TO USE
SAVE THESE INSTRUCTIONS

YEA, THE BORING STUFF ... *but read it, so you don't jack things up!* "apologies, to all the Jacks in the world"

CAUTION: Avoid potential personal injuries and property damage!

- **FOR LOW VOLTAGE CABLES ONLY.**
- **RISK OF FIRE** - DO NOT install power supply cord within the wall cavity.
- Do not use this product for any purpose not explicitly specified by manufacturer.
- Manufacturer is not responsible for damage or injury caused by incorrect assembly or use.
- If you do not understand these instructions or have doubts about the safety of the installation, assembly or use of this product, contact The Echogear Pros at www.echogear.com.

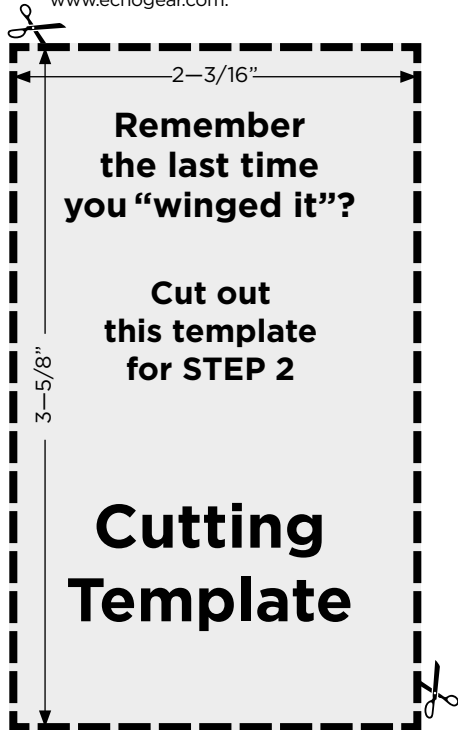

Legrand AV Inc.
6436 City West Parkway
Eden Prairie, MN 55344 USA
P: 1-855-428-2490
helpmehelpyou@ECHOGEAR.com
ECHOGEAR.com

Legrand AV Netherlands B.V.
Franklinstraat 14 6003 DK Weert,
Netherlands
P: +44 (0) 800 0568188
helpme@ECHOGEAR.com
ECHOGEAR.com

Legrand Australia
Unit 20 / 33 Meakin Road
Meadowbrook QLD 4131, Australia
P: +61 (0) 7 3299 7000
ECHOGEAR.com

©2019 Legrand AV Inc.
All Rights Reserved.
ECHOGEAR is a Legrand AV Inc.
brand and a registered trademark
owned by Legrand.
Made in China.

GRAB YOUR TOOLS

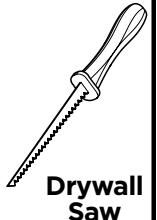
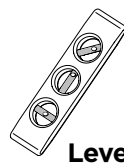
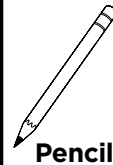

Confuzzled?

Contact the **ECHOGEAR Pros:**

1-855-428-2490

helpmehelpyou@ECHOGEAR.com

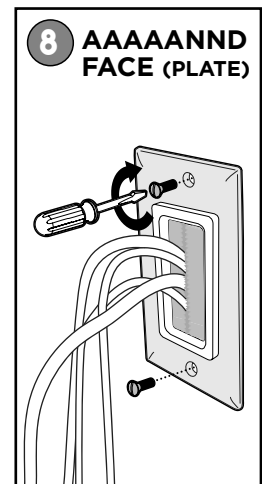
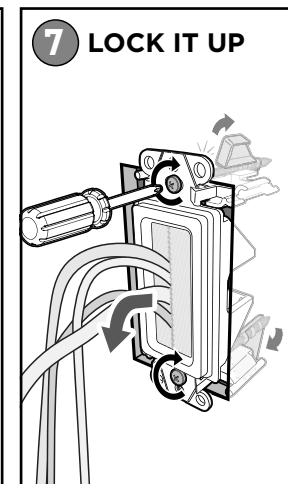
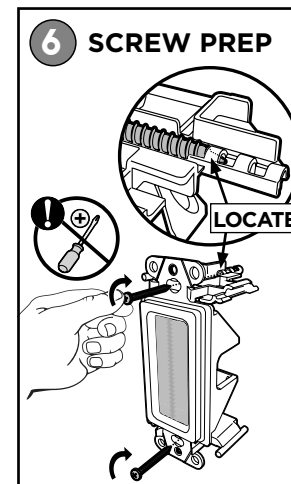
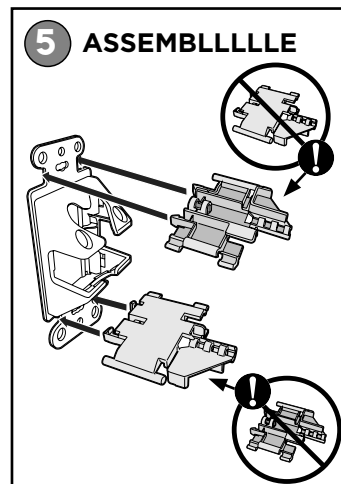
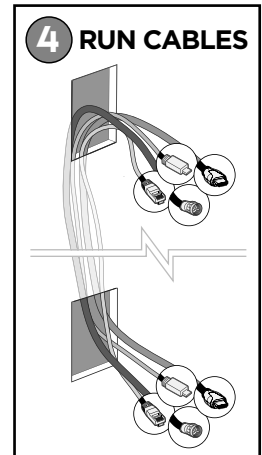
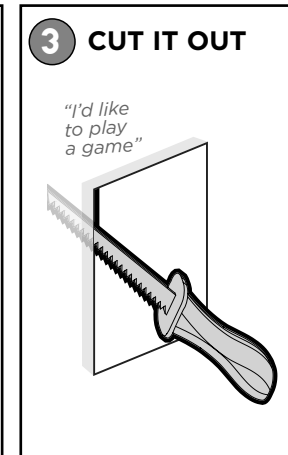
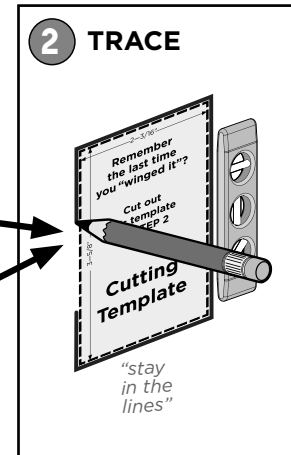
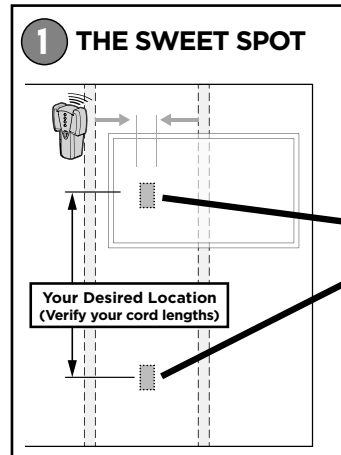

Legrand AV Inc. and its affiliated corporations and subsidiaries (collectively, "Legrand"), intend to make this manual accurate and complete. However, Legrand makes no claim that the information contained herein covers all details, conditions, or variations. Nor does it provide for every possible contingency in connection with the installation or use of this product. The information contained in this document is subject to change without notice or obligation of any kind. Legrand makes no representation of warranty, expressed or implied, regarding the information contained herein. Legrand assumes no responsibility for accuracy, completeness or sufficiency of the information contained in this document.